



顺恩机械（广州）有限公司

Guangzhou Hessan Woodworking Machinery Co.,Ltd

广州市番禺区沙湾镇市良路924号

No.924 Shiliang Road Shawan Town, Panyu District, Guangzhou, China

☎ 020-3483 5968 ✉ info@gzhessan.com.cn

🖨 020-3483 5982 🌐 <http://www.hessan-mc.com>



中文网站



English Website



抖音 (TikTok)



合源机械

Hessan woodworking machinery

Specialize in providing machinery for panel laminating and profile wrapping

COMPANY PROFILE



Guangzhou Hessian Woodworking Machinery Co., Ltd which was established in 2009 is located in Shawan Town, Panyu District, Guangzhou City, Guangdong Province, China. With more than 8,000 square meters of workshop, as well as an independent office building and dormitory building. The company has been committed to the research and development, production of sheet flat laminating equipment and profile wrapping equipment, the company's PUR flat laminating production line produced by the good quality, mature technology, finished product effect, stability, in addition to the commitment to quality, we are also known for first-class service, won the majority of customers at home and abroad praise and word of mouth, "Hessian Machinery " is recognized as a leading brand in the industry!

At present the company's main products are:

First, PUR large board flat laminating production line: suitable for laminating PET, PVC, PP, PU, aluminum film, CPL and other rolled materials, as well as acrylic, HPL fireproof board, aluminum, rock board and other sheet materials.

Second, large panel wrapping/profile wrapping machine: suitable for all kinds of manufactured panels, indoor and outdoor profile surface wrapping and special material profile wrapping processing.

Cold glue paper coating production line: It is suitable for water glue coating of decorative paper and PVC, and the products can have the functions of oil heat conduction, hydraulic pressure, pressure return, embossing, automatic loading and unloading etc.

Other production lines: Acrylic-PVC and PET-PVC laminating line, honeycomb door laminating line, flooring laminating line, front splicer/side splicer.

Other ancillary equipment: automatic board loading and unloading machine, flap machine, sanding machine, vacuum machine, dust removal machine, plate grinding machine, laying pearl cotton machine, slitting machine, hot melt adhesive machine etc.

PUR平贴生产线系列 PUR Panel Laminating Production Line

Introduction:

This machine line is for PUR hot melt glue which is for the lamination of various kinds of material, it's especially good for the lamination of high gloss materials. PUR hot melt glue is a kind of the adhesive which reacts with the moisture in the air, no smell, no harming.

Materials:

Panel: Partical board, MDF, Plywood, Plastic board, gypsum board foamed plastic board etc.

Cover Material: PET, PVC, PP, PU, aluminum film and other coiled materials.

Glue: PUR hot melt adhesive

BASE MATERIAL



Particleboard



Ecological board



Medium Density Fibreboard



Multi-layer board



Bamboo Fiberboard

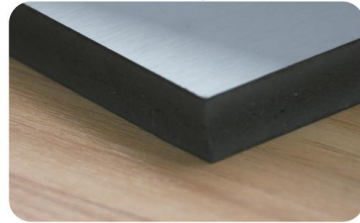

Foam board



Aluminum honeycomb panel



Mgo board



SPC board

SURFACE MATERIAL



PVC Film

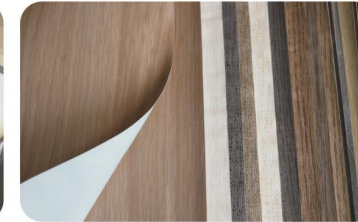

PP Film



PET Film



Metal film



HPL Film



CPL Film



Veneer



Acrylic



PU

PUR卷材平贴生产线

PUR film laminating production line

HY-PUR-1400A

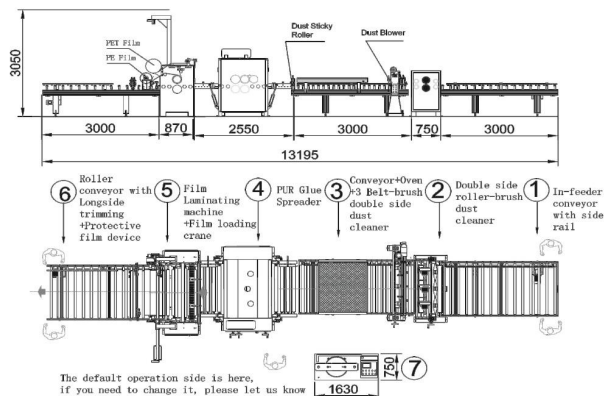

Total power	85kw
Installation area	20x6m
Production cycle	15 working days
Coating cost	1.5-4.5USD/m ²
Staffing	4-5 people
Line speed	5-17m/min
Capacity	800-1200pcs/day

PUR卷材/片材平贴生产线

PUR film/sheet laminating production line

HY-PUR-1400B

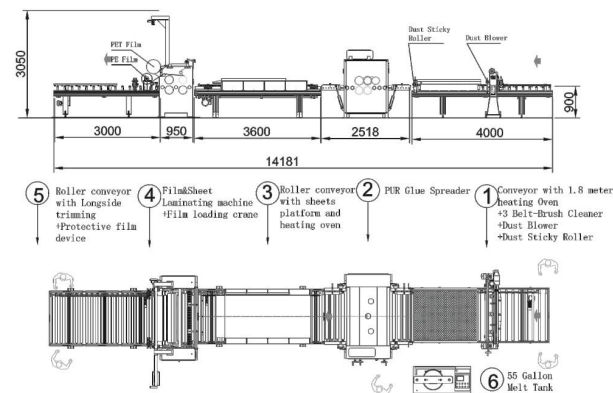

Total power	97kw
Installation area	20x6m
Production cycle	15 working days
Coating cost	1.5-4.5USD/m ²
Staffing	5-6 people
Line speed	5-17m/min
Capacity	800-1200pcs/day

PUR全自动卷材/片材平贴生产线

PUR Automatic film/sheet laminating production line

HY-PUR-1400D

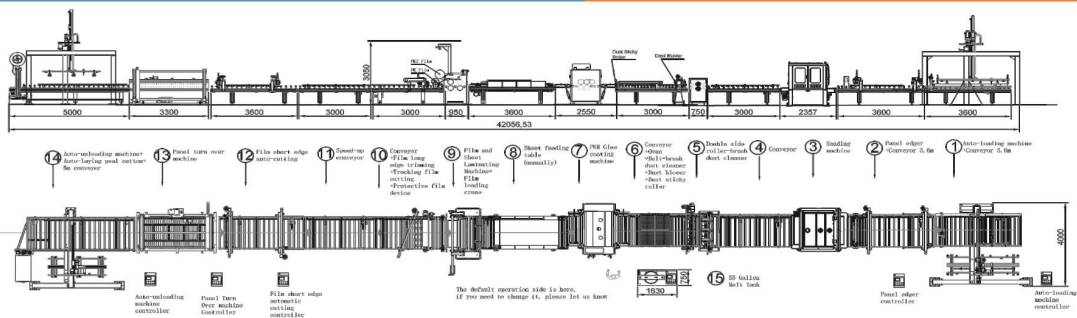

Total power	158kw
Installation area	47x6x5.5m
Production cycle	30 working days
Coating cost	1.5-4.5USD/m ²
Staffing	2-3 people
Line speed	10m/min
Capacity	800-1200pcs/day

PUR地板覆合生产线

PUR flooring lamination line

HY-PUR-500

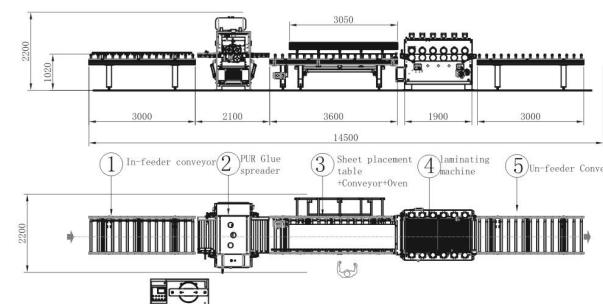

Total power	7kw
Installation area	20x6m
Production cycle	45 working days
Staffing	6 people
Line speed	5-17m/min
Capacity	800-1200pcs/day

PUR蜂窝板、门板压合生产线

PUR Honey-comb lamination line

HY-H-1400

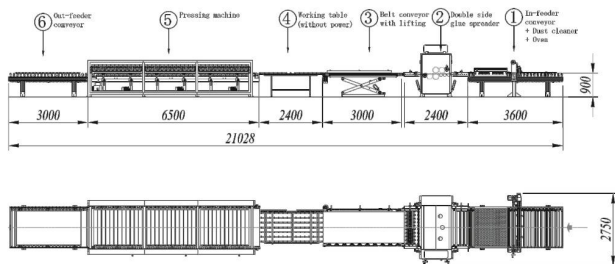

Total power	55kw
Installation area	28x6m
Production cycle	45 working days
Staffing	6 people
Line speed	10m/min
Capacity	800-1200pcs/day

配置选择

CONFIGURATION SELECTION



TLM-01 龙门上料机
TLM-01 Auto loading machine



TLM-02 龙门下料机
TLM-02 Auto unloading machine

配置选择

CONFIGURATION SELECTION



TSS 输送排 (3m/3.6m/4m)
TSS conveyor (3m/3.6m/4m)



TSS-E 烘道输送排(1.2m/1.8m/3m)
TSS-E Oven conveyor (1.2m/1.8m/3m)

配置选择

CONFIGURATION SELECTION

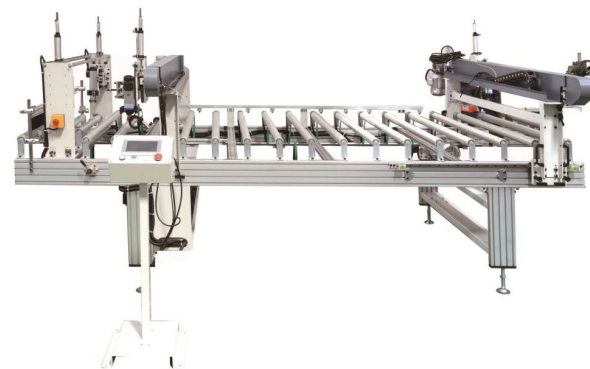

TSS-R 磨边倒角机
TSS-R panel edger



HY-TS 砂光机
HY-TS Panel sanding machine

配置选择

CONFIGURATION SELECTION

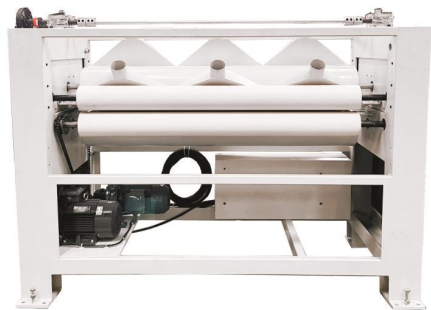

TCC-A 毛扫辊双面除尘机
TCC-A Double side roller brush dust cleaner

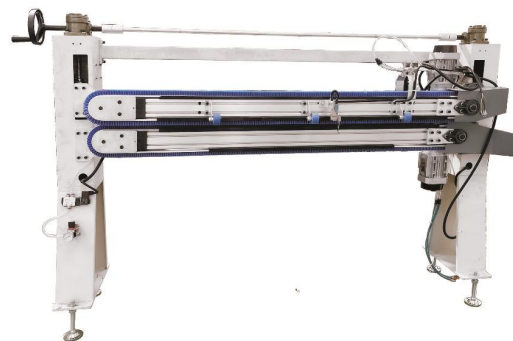

TCC-C 三皮带毛扫静电双面除尘机
TCC-C Double side belt brush dust cleaner

配置选择

CONFIGURATION SELECTION



TTJ-A/B PUR精密涂胶机
TTJ-A/B PUR glue spreader



TTJ-C PUR双面涂胶机
TTJ-C PUR double side glue spreader

配置选择

CONFIGURATION SELECTION



TSS-B 片材输送排 (保温烘道)
TSS-B Sheet table conveyor with oven



TBC-02 自动片材上料输送排 (保温烘道)
TBC-02 Automatic sheet feeding conveyor with oven

配置选择

CONFIGURATION SELECTION



TTH-M 两辊贴合机 (配吊机)
TTH-M Two roller laminating machine with crane



TTH-B 四辊贴合机 (配吊机)
TTH-B Four roller laminating machine with crane

配置选择

CONFIGURATION SELECTION



TBF 修长边+贴保护膜装置+输送排
TBF Long side trimming & protective film device & conveyor



TQD-A 跟踪切断输送排
TQD-A Automatic film cutting with conveyor

配置选择

CONFIGURATION SELECTION



TSS-X 自动修膜短边机+输送排
TSS-X Automatic edge trimmer with conveyor

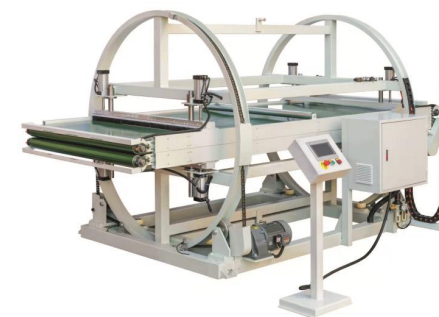

HY-TF 圆柱翻板机
HY-TF Panel turning machine



HY-M5 溶胶机
HY-M5 PUR melter



HY-M55 溶胶机
HY-M55 PUR melter

冷胶平贴生产线系列

Cold Glue Panel Laminating Production Line

Introduction:

These production lines are specialize in sticking the decorating paper or PVC on the MDF, chipboards and plywood for producing panel of furniture which high efficient capability and pressure create a smoothly excellent surface of the finished product. It' s your idea equipment of plywood & furniture company.

Materials:

Panel: Plywood, particleboard, hardboard, MDF, Gypsum board

Cover Material: Decorating paper, PVC foils, PU paper

Glue: PVAC glue, latex glue, UF glue

水胶板材贴面生产线 (气压)

Cold glue lamination line (Pneumatic pressing)

HY-T-338B

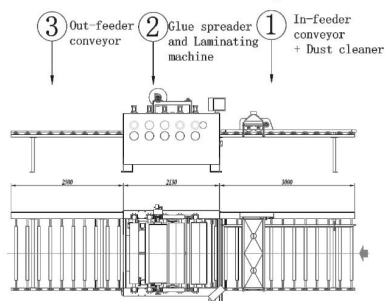

Total power	9.5kw
Installation area	10x6m
Production cycle	30 working days
Staffing	4-5 people
Line speed	11m/min
Capacity	2000pcs/day

水胶板材贴面生产线 (气压)

Cold glue lamination line (Pneumatic pressing)

HY-T-668B

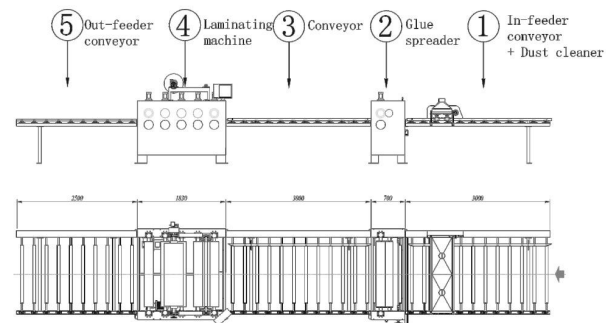

Total power	15kw
Installation area	17.5x6m
Production cycle	30 working days
Staffing	4-5 people
Line speed	5-25m/min
Capacity	2000-4000pcs/day

全自动板材贴面生产线 (液压)

Automatic cold glue lamination line (Hydraulic pressing)

HY-T-1400

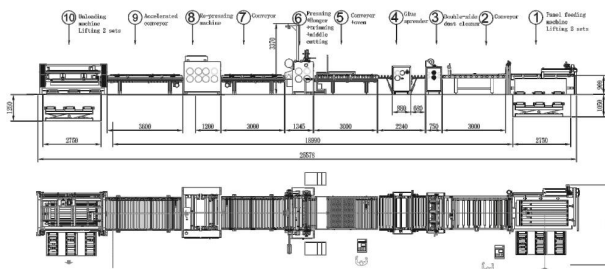
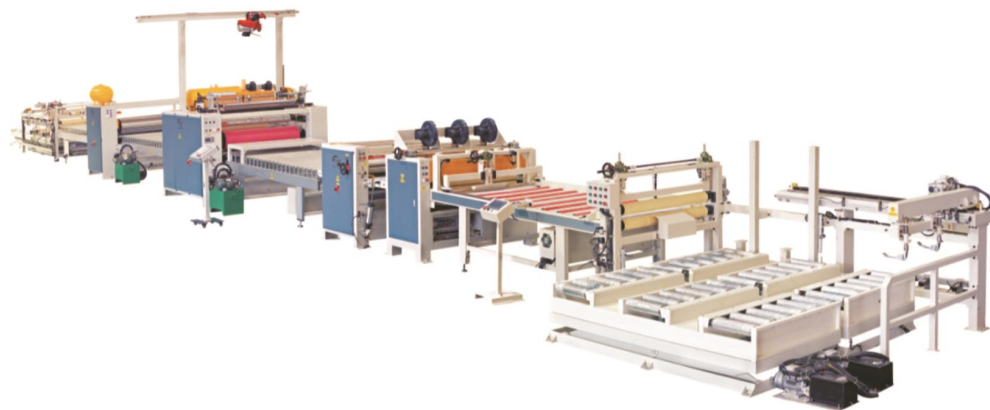

Total power	80kw
Installation area	34x6m
Production cycle	45 working day
Staffing	2-3 people
Line speed	5-25m/min
Capacity	2000-4000pcs/day

亚克力片材贴合生产线

Acrylic sheet making machine

HY-T-1350

Introduction:

This machine is specialized for lamianting the transparent arylc sheet with the thin PVC, it can make many diffence patten,colour arylc sheet.

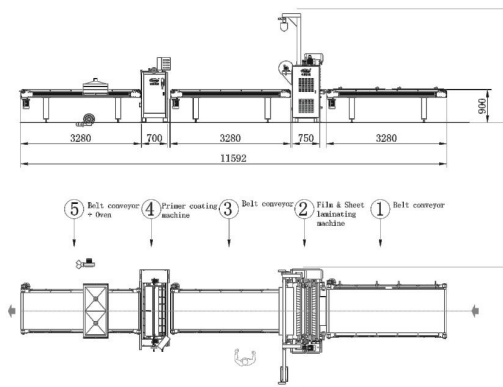

Total power	17kw
Installation area	20x6m
Production cycle	30 working days
Staffing	6 people
Line speed	5-25m/min
Capacity	2000-3000pcs/day

包覆系列

Wrapping machine series

Introduction:

Using with PUR hot melt glue, EVA hot melt glue or cold glue can do different kind of material, like PVC, veneer, paper, CPL ect and base profile for MDF, WPC, PVC plastic, Aluminum.
Which suitable for various feild of profile such as door, windows,picture frame,flooring ect.

Materials:

Panel: Plywood, Particle board, MDF, Solid wood, Aluminum, WPC.

Cover Material: Veneer, paper, PP, CPL, PVC etc.

Glue: EVA/PO hot melt glue, PVAC glue, PU solvent glue, PUR hot melt glue.

EVA/PO热胶线条包覆机

EVA/PO Hot glue profile wrapping machine

HY-FA-400/600

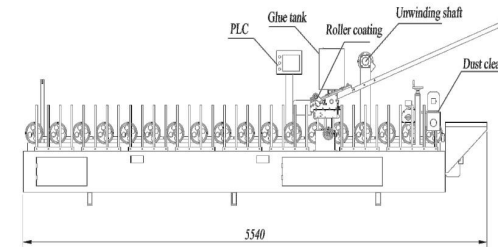

Applicable panel	Plywood, Particle board, MDF
Applicable cover material	Veneer, paper, PP, CPL
Applicable glue	EVA/PO Hot glue
Total power	5.5kw
Installation area	5x1m
Production cycle	35 working days
Staffing	2-3 people
Line speed	2-25m/min
Capacity	7200m/day

冷胶线条包覆机

Cold glue profile wrapping machine

HY-FB-400/600

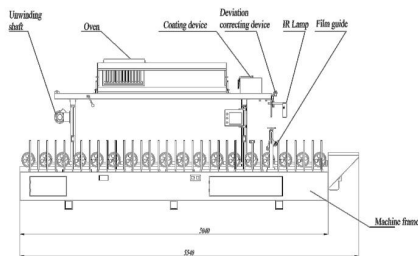
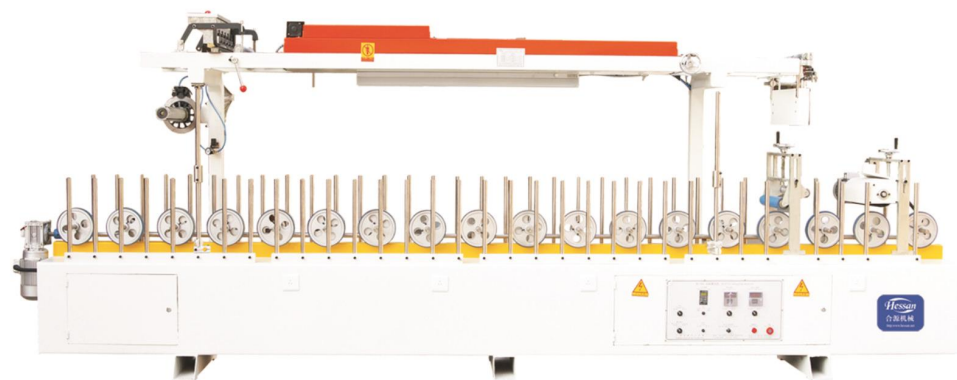

Applicable panel	Particleboard, MDF, Aluminum, WPC.
Applicable cover material	Decorating paper, PVC foils, PU paper
Applicable glue	PVAC glue, PU solvent glue.
Total power	9kw
Installation area	5.5x1m
Production cycle	35 working days
Staffing	2-3 people
Line speed	2-25m/min
Capacity	7200m/day

冷热胶线条包覆机

Cold & Hot glue profile wrapping machine

HY-FC-400/600

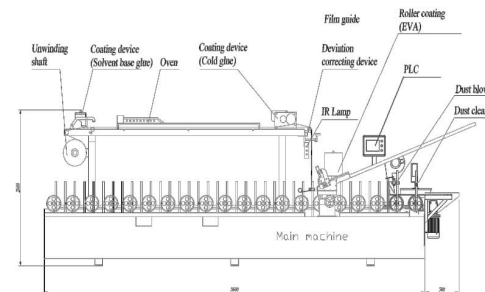
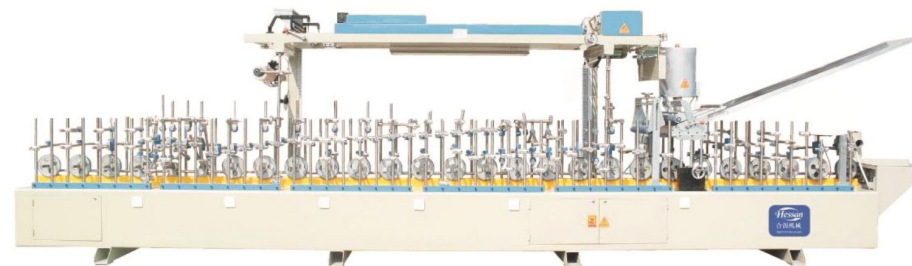

Applicable panel	Particleboard, MDF, Aluminum, WPC etc.
Applicable cover material	Decorating paper, PVC foils, PU paper, Veneer, PP, CPL
Applicable glue	PVAC glue, PU solvent glue, EVA/PO hot melt glue.
Total power	18kw
Installation area	5.5x1m
Production cycle	45 working days
Staffing	2-3 people
Line speed	2-25m/min
Capacity	7200m/day

PUR 热熔胶线条包覆机

PUR Hot glue profile wrapping machine

HY-FE-350/450/650

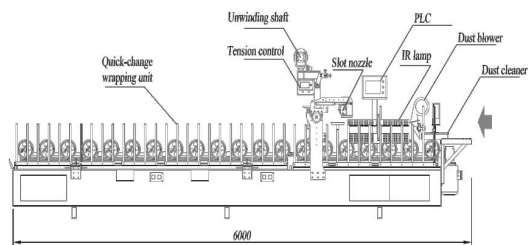

Applicable panel	Particleboard, MDF, Aluminum, WPC etc.
Applicable cover material	Decorating paper, PVC foils, PU paper, Veneer, PP, CPL etc.
Applicable glue	PUR hot melt glue.
Total power	23kw
Installation area	6x2mm
Production cycle	35 working days
Staffing	2-3 people
Line speed	2-25m/min
Capacity	12000-18000m/day

PUR板面平贴包覆生产线

PUR Hot glue panel laminating and wrapping machine

HY-FE-1300L

Introduction:

This machine is professional for wrapping battens of cupboards and wardrobes. Especially for high gloss foils, it can make the surface very shiny and smooth without orange skin. No edge bending, no bending mark, no debonding. With auto trimming and cutting devices, it will make your production easy and efficient.

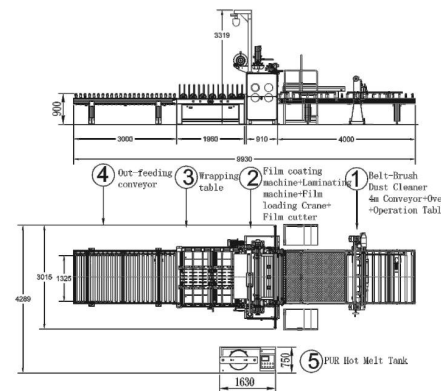

Applicable panel	Particleboard, MDF, Aluminum, WPC etc.
Applicable cover material	Decorating paper, PVC foils, PU paper, Veneer, PP, CPL etc.
Applicable glue	PUR hot melt glue.
Total power	39kw
Installation area	15.7x4m
Production cycle	30 working days
Staffing	4-5 people
Line speed	5-17m/min
Capacity	800-1200pcs/day

PUR胶360条板包覆生产线

PUR Hot glue panel wrapping machine

HY-FE-1300W

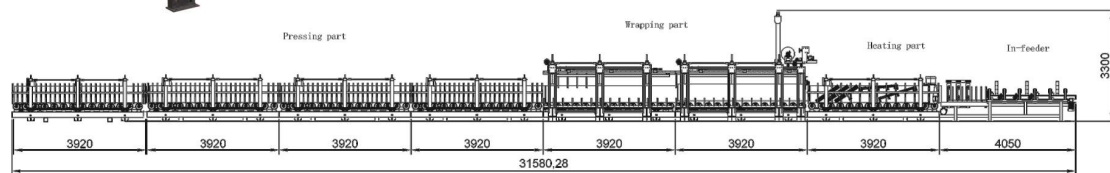

Introduction

FE-1300W that mean the maximum working width of the paper and PVC film width is 1300mm, and heigh of panel is maximum size from 450-600mm. The machine use PUR hot melt glue with a width flexible adjust system slot nozzle and 55 gallon hot melt tank. Panel Auto feeding system, ckening brushing system, panel preheating system also including.

Applicable panel	Plywood, Particle board, MDF etc.
Applicable cover material	Decorating paper, PVC foils, PU paper, PP etc.
Applicable glue	PUR hot melt glue.
Total power	56kw
Installation area	31x2.5m
Production cycle	45 working days
Staffing	5-6 people
Line speed	5-20m/min
Capacity	800-1200pcs/day

PUR/EVA/PO 热胶正拼贴合机

PUR/EVA/PO Glue profile piece-together machine

HY-J-300

Introduction

This machinery are special for gluing the hot melt glue on the strip profile and pressing the strip on the top of another profile which for create the preparatory of the profile and for the next step mould processing.

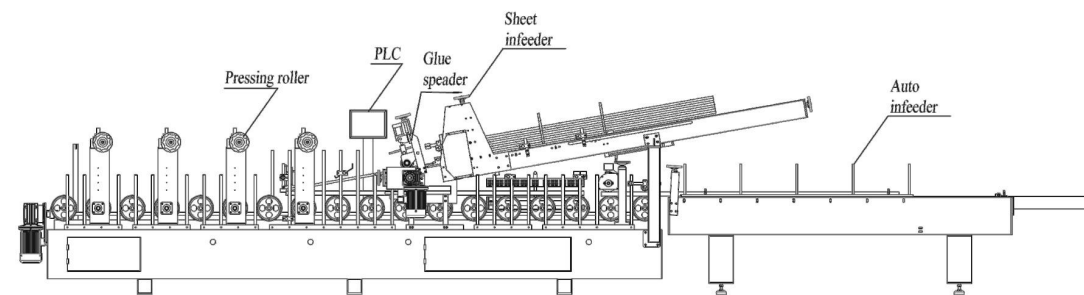

PUR/EVA/PO 热胶侧拼贴合机

PUR/EVA/PO Glue profile side splicer machine

HY-SJ-300

Introduction

This machine is special for making adjustable door frames for different wall widths. It makes "L" shape profiles by sticking 2 laths together. Combined with auto feeder, this machine is very deal for door, picture frame manufacturers.

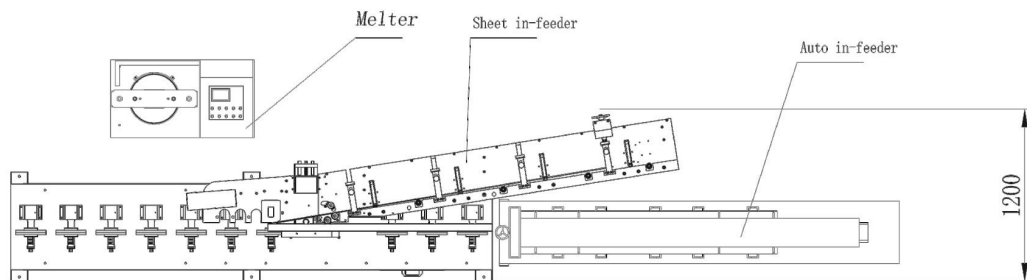
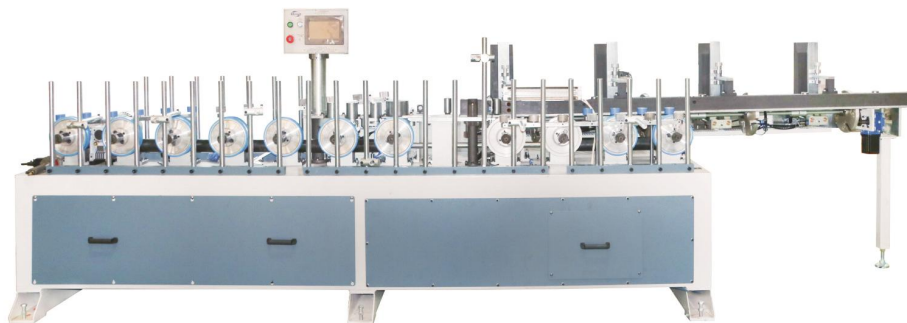

分切机

SLITTING MACHINE



平刀分切机HY-C-1350A
Slitting machine HY-C-1350A



圆刀分切机HY-C-1350B
Slitting machine HY-C-1350B

公司资质

CERTIFICATES

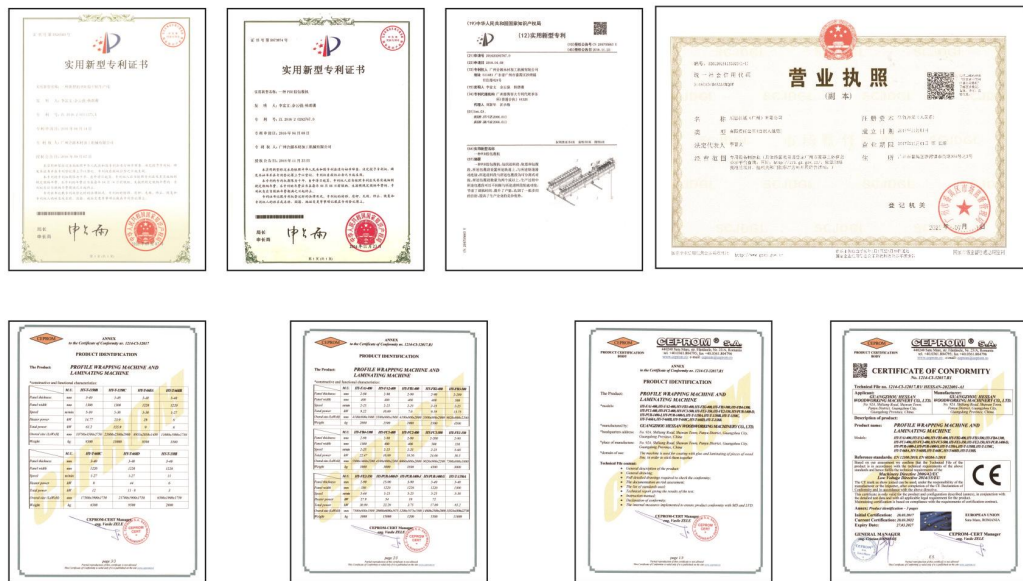

工厂及展会

FACTORY & EXHIBITION



合作客户

COOPERATION

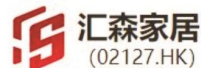

欧派家居集团股份有限公司
索菲亚家居股份有限公司
广东志华集团
东莞时兴家具有限公司
凯跃集团光禾木业
广东联邦家私集团有限公司
浙江得力集团

广州好莱客创意家居股份有限公司
全友家私有限公司
山东千年舟新材科技集团
万华化学（北京）有限公司
江西汇森家俱
江苏吉福新材料有限公司

合作客户

COOPERATION

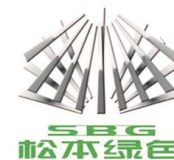

广东耀东华装饰材料科技有限公司
佛山艺巢新型材料科技有限公司
京木（中国）创意展示有限公司
沈阳美家板集团
辽宁中意厨房设备有限公司
湖南愿景建筑科技有限公司
广州市腾龙门业实业有限公司

广东松本绿色新材股份有限公司
深圳远超智慧股份有限公司
骊住通世泰建材（大连）有限公司
沈阳远景贸易有限公司
东莞市冠瑞家具有限公司
河北亿隆装饰材料有限公司